



Models 25B & 28B CW Microwave Frequency Counters

Operation Manual

25B CCN 9107
28B CCN 9207

Manual Assy Part Number: 5585057-08
Manual Text Part Number: 5580089-08
Printed in USA

Warranty

Phase Matrix, Inc. warrants this product to be free from defects in material and workmanship for one year from the date of delivery. Damage due to accident, abuse, or improper signal level is not covered by the warranty. Removal, defacement, or alteration of any serial or inspection label, marking or seal may void the warranty. Phase Matrix, Inc. will repair or replace, at its option, any components of this product which prove to be defective during the warranty period, provided the entire unit is returned COLLECT to Phase Matrix, Inc. or an authorized repair facility. Please visit our web site at: www.phasematrix.com for up-to-date return information. In warranty units will be returned freight prepaid; out of warranty units will be returned freight COLLECT. No other warranty other than above is expressed or implied.

Certification

Phase Matrix, Inc. certifies this instrument to be in conformance with the specifications noted herein at time of shipment from the factory. Phase Matrix, Inc. further certifies that its calibration measurements are traceable to the National Institute of Standards and Technology (NIST).

Manual Change Information

As Phase Matrix, Inc. continually improves and updates its products, changes to the material covered by the manual will occur. When a part or assembly in a Phase Matrix, Inc. instrument is change to the extent that it is no longer interchangeable with the earlier part, the configuration control number (CCN) of the instrument, shown on the title page of the manual, will change, and a new edition of the manual will be published.

To maintain the technical accuracy of the manual, it may be necessary to provide new or additional information with the manual. In these cases, the manual is shipped with a Manual update. Please be sure to incorporate the information as instructed in the Manual update.

SAFETY

The EIP Models 25B and 28B have been designed and tested according to international safety requirements, but as with all electronic equipment, certain precautions must be observed. This manual contains information, cautions, and warnings that must be followed to prevent the possibility of personal injury and/or damage to the instrument.

SAFETY AND HAZARD SYMBOLS

WARNING

The WARNING sign denotes a hazard. It calls attention to a procedure or practice, which, if not correctly performed or adhered to, could result in personal injury.

CAUTION

The CAUTION sign denotes a hazard. It calls attention to an operating procedure or practice, which, if not correctly performed or adhered to, could result in damage to or destruction of part or all of the product.



Dangerous Voltage



Toxic Substance



Static sensitive component



Fire Hazard



This is a general warning that appears whenever care is necessary to prevent damage to the equipment.

OVERALL SAFETY CONSIDERATIONS

WARNING



Before this instrument is switched on, the protective earth terminals of this instrument MUST be connected to the protective conductor of the ac power cord. The main plug shall only be inserted in a socket outlet provided with a protective earth contact. The protective action must not be negated by the use of an extension cord (power cable) without a protective earth (grounding) conductor. Any interruption of the protection will cause a potential shock hazard that could result in personal injury.

WARNING _____



Only fuses with the required rated current, voltage and specified type should be used. **DO NOT** use repaired fuses or short-circuited fuseholders. To do so could cause a shock or fire hazard.

WARNING _____



Disconnect the AC supply lead before removing the covers to avoid the risk of shock hazard. All internal adjustments or servicing done with the AC supply lead connected, must be performed by qualified personnel.

WARNING _____



The power supply filter contains capacitors that may remain charged after the equipment is disconnected from the AC supply lead.

WARNING _____



When the power switch is in the STBY (standby) position, certain parts of the equipment remain at the AC supply potential.

WARNING _____



Some of the components used in this instrument include resins and other chemicals that give off toxic fumes if incinerated. Be sure to dispose of these items properly.

WARNING _____



Beryllia (beryllium oxide) is used in the construction of the YTF assembly. This material, if handled incorrectly, could pose a health hazard.

CAUTION _____



Before connecting power to the instrument, check to insure that the correct fuse is installed and the voltage select switch on the rear panel of the instrument is set properly. Refer to Section 2, Installation.

CAUTION _____



Excessive signals can damage these instruments. To prevent damage, do not exceed specified damage level. Refer to specifications listed in Section 1.

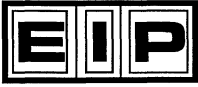

This Page Intentionally Left Blank.

TABLE OF CONTENTS

Warranty	iii
Certification	iii
Manual Change Information	iii
Customer Suggestion Form	iii
Safety	iv

SECTION 1 - GENERAL INFORMATION

Description	1-1
Specifications	1-1
Options and Accessories	1-5

SECTION 2 - INSTALLATION

Unpacking and Initial Inspection	2-1
Storage Environment	2-1
Operating Conditions	2-1
Installation	2-1
Preparation For Use	2-2
Voltage Selection	2-2
Fuse Replacement	2-2
Incoming Operational Checkout	2-3
Service Information	2-4
Periodic Maintenance	2-4
Counter Identification	2-4
Factory Service	2-4
Shipping Instructions	2-4

SECTION 3 - OPERATION

Introduction	3-1
Front Panel Controls, Indicators, and Connectors	3-1
Power Switch	3-2
Data Display	3-2
Status Indicators	3-2
Signal Input Connectors	3-3

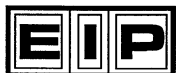

TABLE OF CONTENTS (Continued)

SECTION 3 - OPERATION (Continued)

- Keyboard 3-4
- Rear Panel Connectors and Control 3-4
- Operation 3-4
 - Power On 3-4
 - Default Settings 3-5
 - Keyboard Operation 3-5
 - Single Key Instructions 3-6
 - Multiple Key Instructions 3-6
- Signal Measurements 3-10
 - Automatic Frequency Measurements 3-10
 - Frequency Measurement in a Multiple Signal Environment 3-10
 - Center Frequency 3-10
 - Frequency Limits 3-10
- Counter Accuracy 3-12
 - Time Base Error 3-12
 - Gate Phasing Error 3-12
- Techniques For Improving Accuracy 3-13
- Calculating Measurement Error 3-13
- Power Meter 3-14
 - Description 3-14
- Special Functions Directory 3-15
 - Activation of Special Functions 3-15
 - Operation Verification Functions 3-15
 - Troubleshooting Functions 3-17
- Mutually Exclusive Functions 3-19
- Error Messages 3-20

SECTION 4 - PROGRAMMING

- Introduction 4-1
- GPIB Functions Implemented 4-1
 - Remote/Local Function 4-1
 - Default State (Device Clear Function) 4-2
 - Device Trigger Function 4-2
- GPIB Address Selection 4-2
 - Talk Only Modes 4-3
- GPIB Instruction Format 4-3

TABLE OF CONTENTS (Continued)

SECTION 4 - PROGRAMMING (Continued)

Formal Definition of Instructions 4-4

Description of Available Commands 4-4

 Display 4-4

 Band 4-4

 Resolution 4-4

 Measurement Functions 4-5

 Data Manipulation Functions 4-5

 Power Meter 4-5

 Frequency Limits 4-5

 Special Functions 4-6

 Data Format 4-6

 Data Output 4-6

 DAC Option 4-6

 Service Request 4-7

Service Request Mask 4-7

Data Output Format 4-9

Program Example 4-10

Reading Measurements 4-10

Input Speed 4-10

SECTION 5 - OPERATIONAL VERIFICATION TESTS

Introduction 5-1

Equipment Requirements 5-1

Source Locking Setup 5-2

Operational Verification Test Procedures 5-3

 Band 1 Range and Sensitivity Test (10 Hz To 10 Mhz) 5-3

 Band 1 Range and Sensitivity Test (20 Mhz To 100 Mhz) 5-4

 Band 2 Range and Sensitivity Test 5-5

 Band 3 Range and Sensitivity Test 5-6

 Band 3 Amplitude Discrimination Test 5-7

Operational Test Record 5-8

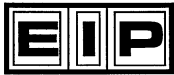

LIST OF ILLUSTRATIONS

Figure		Page
2-1	Rear Panel Fuse and Voltage Select Switch Locations.	2-2
3-1	Front Panel (25B Shown).	3-1
3-2	Status Display.	3-2
3-3	Signal Input Connectors (Model 25B Shown).	3-3
3-4	Rear Panel.	3-3
3-5	Keyboard.	3-5
3-6	Measurement Display at 0.1 Hz Resolution (25B Shown).	3-9
3-7	Center Frequency.	3-11
3-8	Frequency Limits.	3-11
3-9	Gate Phasing Error.	3-13
4-2	Status Byte Structure.	4-7
5-1	Source Locking Setup.	5-2
5-2	Band 1 Range and Sensitivity Test Setup (10 Hz to 10 MHz).	5-3
5-3	Band 1 Range and Sensitivity Test Setup (20 MHz to 100 MHz).	5-4
5-4	Band 2 Range and Sensitivity Test Setup.	5-5
5-5	Band 3 Range and Sensitivity Test Setup.	5-6
5-6	Band 3 Amplitude Discrimination Test Setup.	5-7
Table		Page
5-1	Equipment Requirements.	5-1

1

GENERAL INFORMATION

DESCRIPTION

The EIP 25B and 28B are microprocessor-based microwave frequency counters that measure the frequency and power of CW signals. The frequency range of the 25B is from 10 Hz to 20 GHz. The frequency range of the 28B is from 10 Hz to 26.5 GHz.

Frequency measurements are divided into three bands. Power measurements can only be made in Band 3. Band 1 is a high impedance input (1 Megohm/20 pF) and covers the frequency range from 10 Hz to 100 MHz, with a sensitivity of 25 mV rms. Band 2 has an input impedance of 50 ohms and covers the frequency range from 10 MHz to 1 GHz, with a sensitivity of -20 dBm. Band 3 has an input impedance of 50 ohms and covers the frequency range from 1 GHz to 20 GHz (26.5 GHz on the 28B), with a sensitivity of -30 dBm from 1 GHz to 12.4 GHz and a sensitivity of -25 dBm from 12.4 to 20 GHz. The 28B has a sensitivity of -20 dBm from 20 to 26.5 GHz.

Through keyboard control and remote operation via the general purpose interface bus (GPIB), the EIP 25B/28B counters provide frequency features such as offsets, frequency multiplication, center frequency, and frequency limits. A high stability time base is available as an option. Measurements are presented on a 12-digit LED display that is sectionalized to read directly in GHz, MHz, kHz, and Hz.

SPECIFICATIONS

GENERAL

Size (H, W, D)	3.5 in. x 8.125 in. x 18.75 in. (8.9 cm x 20.6 cm x 47.6 cm)
Net Weight	20 lbs (9.1 kg)
Shipping Weight	26 lbs. (11.8 kg)
Operating Temperature	32 to 122 °F (0 to 50 °C)
Power	100/120/140/200/220/240 Vac \pm 10%, 50-400 Hz, 60 VA typical
Resolution	0.1 Hz to 10 MHz in Band 1 1 Hz to 1 GHz in Bands 2 and 3

**SPECIFICATIONS (Continued)****GENERAL (Continued)**

Gate Time	
Band 1	1 ms to 10 s (depending upon resolution)
Band 2 and 3	1 ms to 1 s (depending upon resolution)

BAND 1

Frequency Range	10 Hz to 100 MHz
Connector	BNC female
Impedance	1 M ohm/20 pF, nominal
Coupling	DC
Sensitivity	25 mV rms
Maximum Input	120 V rms*
Damage Level	150 V rms *
Maximum FM	Carrier frequency must remain within band
Tracking Speed	Carrier frequency must remain within band

* Above 1 kHz, damage level decreases @ 6 dB/octave down to 3.0 V rms.

BAND 2

Frequency Range	10 MHz to 1 GHz
Connector	BNC female
Impedance	50 Ω , nominal
Coupling	AC
Sensitivity	-20 dBm
Maximum Input	+10 dBm
Damage Level	+27 dBm
Maximum FM/Chirp	Carrier frequency must remain within band
Acquisition Time	<50 ms
Tracking Speed	>800 MHz/s, typical

BAND 3

Frequency Range	25B: 1 GHz to 20 GHz 28B: 1 GHz to 26.5 GHz
Connector	25B: Precision Type N female 28B: APC 3.5 female
Impedance	50 Ω , nominal
Coupling	AC
VSWR	2.5:1, typical

SPECIFICATIONS (Continued)

BAND 3 (Continued)

Sensitivity	-30 dBm: 1 GHz to 12.4 GHz -25 dBm: 12.4 GHz to 20 GHz -20 dBm: 20 GHz to 26.5 GHz (28B only)
Maximum Input Damage Level	+10 dBm +45 dBm (30 watts) continuous power +53 dBm (200 watts) pulsed power ($\leq 1 \mu\text{s}$ pulse width, 0.1% duty cycle)
Amplitude Discrimination	10 dB. If <10 dB, will count one signal accurately if separated by >200 MHz.
Maximum FM/Chirp Acquisition Time	20 MHz peak-to-peak up to 10 MHz rate <200 ms standard. <20 ms center frequency mode.
Center Frequency	Will lock on signals ≤ 5 MHz from the entered frequency at sensitivity; resolution is 1 MHz. Equal amplitude signals must be separated by ≥ 40 MHz from 1 GHz to 20 GHz and ≥ 60 MHz from 20 GHz to 26.5 GHz. Unwanted signals that are higher in amplitude than the desired signal require greater separation.
Tracking Speed	>800 MHz/s, typical
Frequency Limits	Keyboard controlled. Counter will measure largest signal within set limits. Signal outside desired range must be separated by ≥ 200 MHz (typical) from either limit.

POWER MEASUREMENT

Frequency Range	25B: 1 GHz to 20 GHz 28B: 1 GHz to 26.5 GHz
Accuracy ^①	± 1.2 dB typical (0 to 50 °C, input padded by 3 dB) ± 0.5 dB typical (25 °C, input padded by 3 dB)
Resolution	Power: ± 0.1 dB Frequency: 100 kHz to 1 GHz (selectable) 1 Hz to 1 GHz (selectable) via GPIB
Minimum Level	Equal to counter sensitivity
Display	Simultaneous frequency and power reading
Offset Range	-99.9 dB to 99.9 dB
Offset Resolution	0.1 dB
Offset Input	Keyboard or GPIB
Measurement Time	1 Gate Time + 50 ms + Frequency Measurement Time
Measurement Window	25 MHz nominal

① Accuracy specified from sensitivity to +7 dBm.



SPECIFICATIONS (Continued)

TXCO Timebase

Frequency	10 MHz
Aging Rate	$<1 \times 10^{-7}$ per month, $<1 \times 10^{-6}$ per year
Short Term Stability	$<1 \times 10^{-9}$ rms for one second averaging time
Temperature Stability	$<1 \times 10^{-6}$ over the range of 0 to 50 °C
Line Variation	$<1 \times 10^{-7}$ for $\pm 10\%$ line voltage change
Warm-up Time	30 minutes
Phase Noise	-95 dBc/Hz at 10 Hz from carrier
Timebase Output	10 MHz at 1 V p-p minimum into 50 ohms from rear panel BNC female connector.

External Timebase

Input	10 MHz at 1 V p-p minimum into 300 ohms applied at rear panel BNC female connector. External timebase operation enabled via Special Function 20.
-------	--

Oven Oscillator Timebase (Option 05)

Frequency	10 MHz
Aging Rate	$<5 \times 10^{-10}$ /day (after 24 hour warm-up), 1×10^{-7} /year
Short Term Stability	$<1 \times 10^{-10}$ rms for one second averaging time
Temperature Stability	$<3 \times 10^{-8}$ over the range of 0 to 50 °C
Line Variation	$<2 \times 10^{-10}$ for $\pm 10\%$ line voltage change
Warm-up	Within 5×10^{-9} of final value 10 minutes after counter is plugged in at 25 °C. Within 1×10^{-9} of final value 30 minutes after counter is plugged in at 25 °C.
Phase Noise	-120 dBc/Hz at 10 Hz from carrier

GPIB Programmability

GPIB	Functions, special functions and diagnostics are programmable. Address selectable via front panel. Compatible IEEE STD-488. SH1, AH1, T5, L3, SR1, RL1, DC1, and DT1 implemented.
------	---

OPTIONS AND ACCESSORIES

- 05 High Stability Oven Timebase
- 011 Rack Mount Kit
- 016 Chassis Slide Kit
- 018 Front Handles
- 021 Transit Case
- 031 Extra Operation Manual (one supplied at no charge with instrument)
- 032 Service Manual (includes Operation Manual)
- 042 Service Kit

DECLARATION OF CONFORMITY

Application Of Council Directive 89/336/EEC

Standards to which Conformity is Declared:

EMC: EN50011
EN50082-1

Standards to which Compliance is Declared:

Safety: IEC 1010-1 (1990)

Manufacturer's Name: EIP/Phase Matrix, Inc.
Manufacturer's Address: 109 Bonaventura Dr.
San Jose, CA 95134
Type of Equipment: Frequency Counter
Model Name(s): 25B/28B
Tested By: Rockford Engineering Services, Inc.
9959 Calaveras Road
Sunol, CA 94586 USA
Project Engineer: Mr. Bruce Gordon and Leo Hernandez
Reviewer: Mr. Michael Gbadebo, P.E.

I, the undersigned, hereby declare that the equipment specified above conforms to Directives and Standards listed.

For: **Phase Matrix, Inc.**

Name: Mark Espinosa
Title: QA Manager

Signature: Mark Espinosa

Date: 11/01/2004

2

INSTALLATION

UNPACKING AND INITIAL INSPECTION

If the shipping container or cushioning material is damaged, it should be kept until the contents of the shipment have been checked for completeness and the instrument has been checked mechanically and electrically. If the contents are incomplete, if there is mechanical damage or defect, or if the instrument does not pass the electrical performance tests, notify EIP in care of the address shown on the title page. If the shipping container is damaged, or the cushioning material shows signs of stress, notify the carrier as well as EIP. Keep the shipping materials for carrier's inspection. EIP will arrange for repair or replacement of the instrument without waiting for claim settlement.

STORAGE ENVIRONMENT

The instrument may be stored or shipped in environments within the following limits:

- Temperature: -40 to +75 °C
- Humidity: Up to 95%
- Altitude: Up to 50,000 feet (15,240 meters)

OPERATING CONDITIONS

This instrument is designed to be operated at temperatures not exceeding 0 to 50 °C at a relative humidity not to exceed 95% (75% over 25 °C and 45% over 40 °C). This instrument will perform to specifications at altitudes not exceeding 10,000ft (3050m) and will tolerate vibrations not exceeding 2 g. It is fungus resistant. The chassis is not designed to provide protection from mechanical shock or falling water particles and is intended for normal bench use in an environmentally clean area.

INSTALLATION

There is no special installation required for the EIP 25B or 28B frequency counter. These units are self-contained bench or rack mounted instruments that only require connection to a standard single-phase power line for operation.

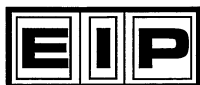

PREPARATION FOR USE



VOLTAGE SELECTION

 **CAUTION** _____
Disconnect ac power cord before changing voltage selection switch.

The voltage selection switch should be set to the proper line voltage. (See Figure 2-1.) To change the line voltage, proceed as follows:

1. Disconnect the counter from the power line.
2. Using a screwdriver, turn the slotted voltage indicator to the desired position.

FUSE REPLACEMENT

  **WARNING** _____
Disconnect ac power cord before replacing fuse.

The fuse for the counter is located on the rear panel, above the line voltage plug. The type of fuse used in your counter depends upon the primary power, as follows:

Line Voltage	Fuse Type
100/120/140 Vac	1.5 A, slow-blow, MDL
200/220/240 Vac	0.8 A, slow-blow, FST

To release the fuse, use a screwdriver to rotate the slotted cap counterclockwise. To reinstall the fuse, press the fuse and slotted cap assembly into the fuse cavity and turn cap clockwise until it locks into place.

CAUTION _____
 **To avoid damage to the counter, always be sure that the fuse used is the type and value specified, and that the voltage select switch is set to correspond to the ac power input voltage. (See Figure 2-1.)**

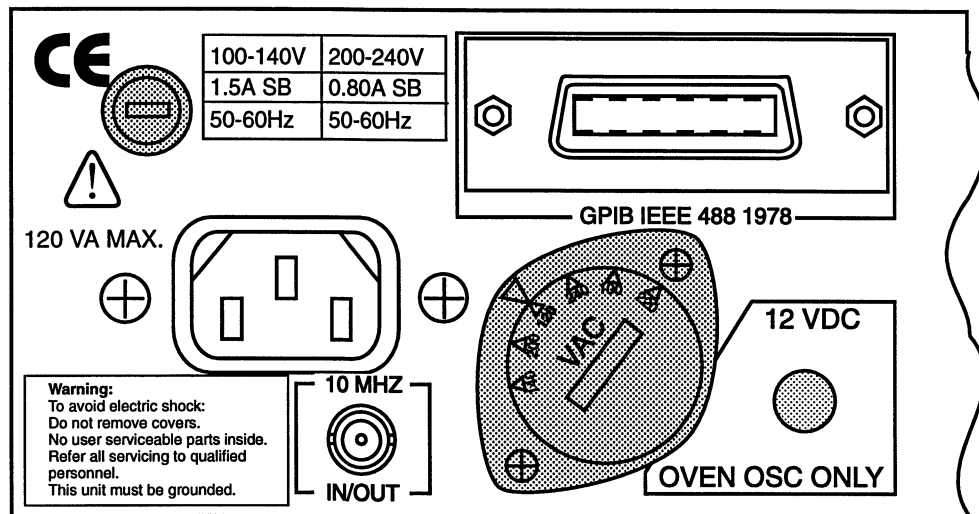

Figure 2-1. Rear Panel Fuse and Voltage Select Switch Locations.

INCOMING OPERATIONAL CHECKOUT

The following tests are designed to provide a basic operational check of the instrument. If more extensive testing is required, refer to Section 5.

1. Before connecting power to the instrument, check the rear panel to make sure the correct fuse is installed and the VAC switch is set properly.
2. Connect the power cord to the appropriate single-phase power source. The ground terminal on the power cord plug must be properly grounded.
3. Turn the POWER switch to ON. A row of dashes will be displayed for about two seconds. The counter should then display all zeros indicating that the automatic self-check has been successfully completed.

4. PRESS:

SPECIAL	3	0	1
FUNC			

 Display should read 200 000 000 \pm 1 count (200 MHz).
5. PRESS:

SPECIAL	3	0	2
FUNC			

 Display should read all 8's and all annunciators should be lit.
6. PRESS:

SPECIAL	3	0	3
FUNC			

 Each display segment should light in turn (adjustable by the front panel SAMPLE RATE control).
7. PRESS:

SPECIAL	3	0	4
FUNC			

 Each digit should light in turn (adjustable by the front panel SAMPLE RATE control).

This completes the incoming operational checkout procedure.

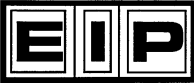

SERVICE INFORMATION

PERIODIC MAINTENANCE

No periodic maintenance is required. However, to maintain accuracy, it is recommended that the counter be recalibrated every 12 months. The specific calibration interval depends upon the measurement accuracy required. For sample measurement error calculations for both 6- and 12-month calibration intervals, see Section 3, "Calculating Measurement Error."

CAUTION



Do not attempt repair or disassembly of the microwave converter or time base oscillator assemblies. Such action will void the warranty on the counter. Contact EIP or your sales representative if these units require servicing.

COUNTER IDENTIFICATION

The counter is identified by three sets of numbers: the model number, a serial number, and a configuration control number. These numbers are located on a label affixed to the frame at the rear of the counter and must be included in any correspondence regarding your counter.

FACTORY SERVICE

If the counter is being returned to EIP for service or repair, be sure to include the following information with the shipment:

- Name and address of owner.
- Model number, serial number, and configuration control number of the counter (listed on the rear panel of the counter).
- A complete description of the problem. (E.g., under what conditions did the problem occur? What was the signal level? What equipment was attached or connected to the counter? Did that equipment also experience failure symptoms?)
- Name and telephone number of someone familiar with the problem who may be contacted by EIP for any further information if necessary.
- Shipping address to which the counter is to be returned. Include any special shipping instructions.

SHIPPING INSTRUCTIONS

Wrap the counter in heavy plastic or kraft paper and repack in original container if available. If the original container cannot be used, use a heavy (275 lb test) double-walled carton with approximately four inches of packing material between the counter and the inner carton. Seal carton with strong filament tape or strapping. Mark the carton to indicate that it contains a fragile electronic instrument. Ship to EIP Microwave, Inc. at the address shown on the front cover.

3

OPERATION

INTRODUCTION

This section lists the controls, connectors, and indicators featured on the EIP 25B/28B frequency counters, explains how each counter function operates, and provides some general measurement considerations.

FRONT PANEL CONTROLS, INDICATORS, AND CONNECTORS

Front panel controls, indicators, and connectors fall into four general groups: data display, status display, signal input, and keyboard. (See Figure 3-1.)

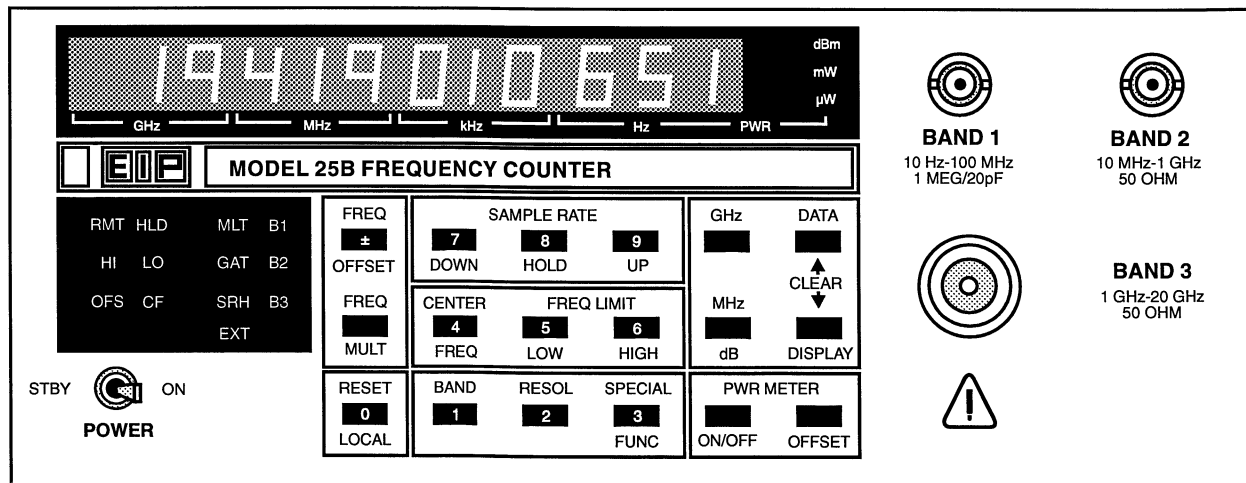

Figure 3-1. Front Panel (25B Shown).

POWER SWITCH

- STBY -In standby (STBY) position, all controls and displays are inactive; power is applied only to optional oven time base (if installed).
- ON -In the ON position, power is applied to the counter circuits and controls.

DATA DISPLAY

The 12-digit LED data display provides a direct numerical readout of an input frequency measurement. The frequency readout is displayed in a fixed-position format that is sectioned into GHz, MHz, kHz, and Hz.

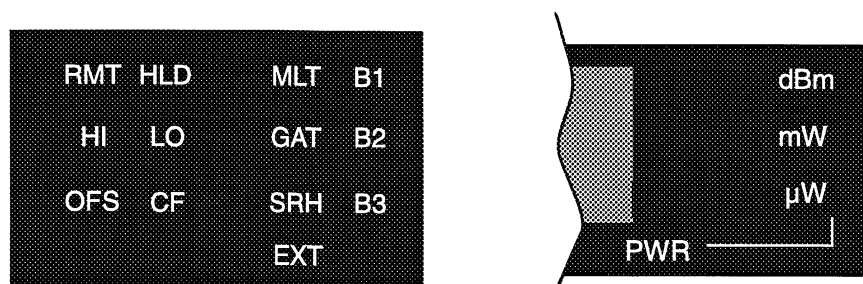

Figure 3-2. Status Display.

STATUS INDICATORS

- RMT -Lights to indicate that the counter is being controlled via the GPIB and that all front panel controls are disabled except the POWER switch and the LOCAL switch.
- HI -Lights to indicate that the Band 3 frequency limit high function is active.
- OFS -Lights to indicate that the frequency offset function is active.
- HLD -Lights to indicate that the counter's measurement cycle is halted. The instrument continues to display the last measurement.
- LO -Lights to indicate that the Band 3 frequency limit low function is active.
- CF -Lights to indicate that the center frequency function is active.
- MLT -Lights to indicate that the frequency multiplying function is active.
- GAT -Lights to indicate that the counter gate is open and a measurement is being made.
- SRH -Lights to indicate that the counter is searching for a signal.
- EXT -Lights to indicate that the counter is set to an external time base reference.
- B1 -Lights to indicate that Band 1 has been selected.
- B2 -Lights to indicate that Band 2 has been selected.
- B3 -Lights to indicate that Band 3 has been selected.
- dBm -Lights to indicate that the Band 3 power meter function is active.
- mW -Not currently used.
- μW -Not currently used.

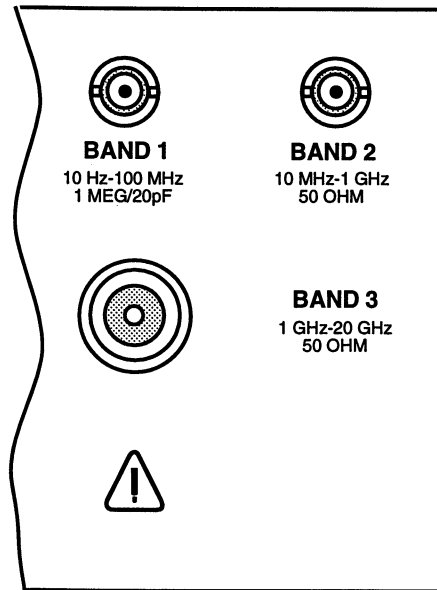

Figure 3-3. Signal Input Connectors (Model 25B Shown).

SIGNAL INPUT CONNECTORS

- BAND 1 -A BNC female connector with a nominal input impedance of 1 megohm shunted by 20 pF.
- BAND 2 -A BNC female connector with a nominal input impedance of 50 ohms.
- BAND 3 -A precision N female connector (25B) or APC 3.5 female (28B) with a nominal input impedance of 50 ohms.

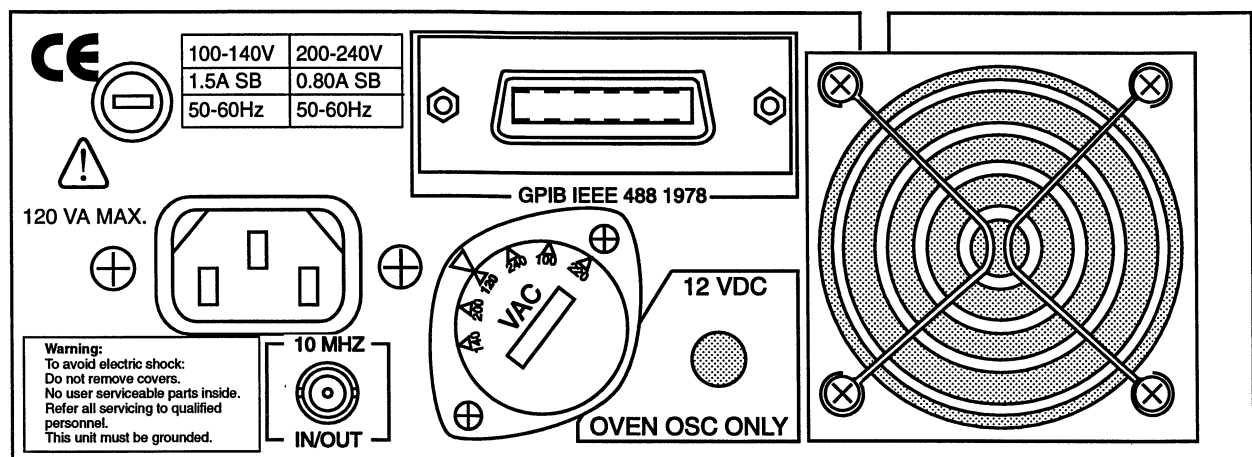
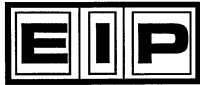

Figure 3-4. Rear Panel.



KEYBOARD

- Both data entry and function selection are controlled through the keyboard. (See keyboard section on page 3-5.)

REAR PANEL CONNECTORS AND CONTROL

- Fuse - Provides current overload protection.
- VAC switch - Matches the operating voltage setting of the counter to the ac power line voltage.

CAUTION



Switch setting and fuse rating must match power line voltage. Refer to Installation section for more information.

- AC power receptacle - Input for ac line cord.
- 10 MHZ ADJ - Not used. Internal adjustment provided for calibrating the internal oven oscillator. (Option 05 only.)
- 10 MHz IN/OUT - The time base input/output. This BNC female connector accepts an external time base reference input or provides an output for the internal time base reference. The state is selectable using Special Functions 20 or 21. (See special functions listing).
- GPIB connector - Used for remote operation with General Purpose Interface Bus.
- +12 VDC Input - Not currently used.

OPERATION

CAUTION



The EIP 25B/28B counters are sensitive measuring instruments. To avoid damage to the instruments, do not exceed the maximum input specifications.

POWER ON

With the counter plugged in and the POWER switch set to STBY, displays and controls are inactive. Power is applied only to the optional oven time base, if installed.

The power-on tests are automatically performed by the counter and verify proper operation of the counter microprocessor and memory circuitry. As part of the power-on tests, the counter checks its RAM and PROM memory. During these tests, dashes are displayed on the front panel. If all tests pass, the counter will begin normal operation about one second after turn-on. If the RAM test fails, all 12 sections of the display will read "E", which indicates that either the RAM or RAM decoding circuit is faulty. If the PROM test fails, an error message will be displayed indicating that either the PROM or the PROM decoding circuitry is faulty.

DEFAULT SETTINGS

When the counter is initially turned on, its state is determined by the default values stored in memory. The factory set default values are shown below.

Parameter	Default Value
Band	3
Center frequency	0 (disabled)
Display	Enabled
Internal reference	Setting last stored in memory
External reference	Setting last stored in memory
Frequency multiply	1
Frequency offset	0
Hold	Off
Resolution	0 (1 Hz)
Sample rate	50 ms

KEYBOARD OPERATION

The keyboard consists of 18 push-button keys that control the major functions of the counter. Twelve of the keys are used for numerical data entry: the digits 0 through 9, the decimal point, and the change sign (\pm). The numeric keys are dual-function keys, since they are also used to: select the frequency offset and frequency multiplier functions; reset the counter (or return to local operation); adjust the sample rate; select the center frequency, frequency limit high, and frequency limit low functions; select the measurement band of the counter; select the counter measurement resolution; or activate any of the counter special functions. Two keys—MHz dB and GHz—are used as command terminators for the input of frequency parameters. The CLEAR DATA and CLEAR DISPLAY keys are used to clear stored or displayed data, respectively. Two keys—PWR METER ON/OFF and PWR METER OFFSET—are used to activate/terminate the power meter function and add power offsets to the displayed power measurement data, respectively.

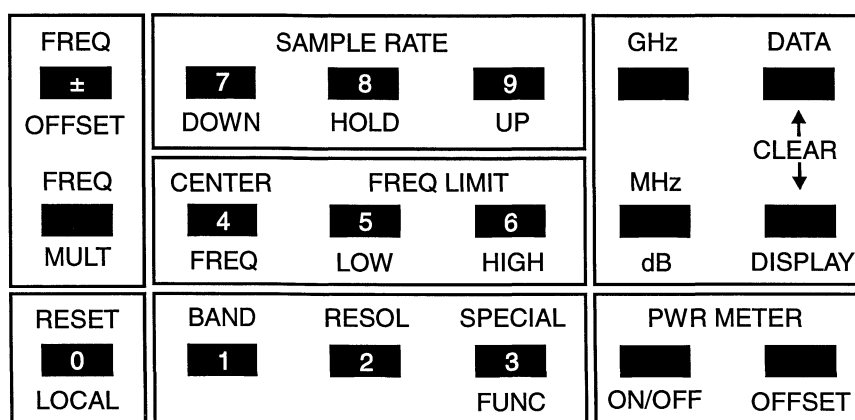
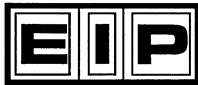

Figure 3-5. Keyboard.



Single Key Instructions

1. Valid Single Key Instructions:

- **RESET LOCAL** - If under front panel (local) control, pressing this key halts the counter measurement or acquisition sequence and initiates a new acquisition sequence. It does not affect the status of any measurement condition set by the front panel controls. If under GPIB control (RMT indicator on), pressing this key returns control to the front panel and initiates a new acquisition sequence.
- **SAMPLE RATE DOWN** - A single press of this key decreases the sample rate one decrement. At minimum sample rate, the time between samples is nominally 10 seconds.
- **SAMPLE RATE HOLD** - Pressing this key puts the counter sample rate into hold, freezes the display on the last measurement made, and lights the HLD indicator.
- **SAMPLE RATE UP** - A single press of this key increases the sample rate one increment. At maximum sample rate, the time between samples is nominally 25 ms.
- **CLEAR DISPLAY** - If the counter is in the data entry mode, pressing this key clears the current entry and returns the counter to the measurement display mode. Pressing this key does not affect stored data.

NOTE

The following commands are invalid single key instructions: GHz, MHz, CLEAR DATA, all numbers, and \pm . None of these keys initiates a single or multiple key instruction. All require a prior key press to initiate a valid instruction set. The counter will display "Error 01" until CLEAR DISPLAY is pressed or a valid instruction set is initiated.

Multiple Key Instructions

- **BAND** - The BAND key initiates the band selection instruction set. Band annunciators B1, B2, and B3 flash until the 1, 2, or 3 key is selected. Counter operation is not affected until an instruction-terminating number is selected. At that time, the counter changes bands, resets, and initiates the proper acquisition sequence for the selected band. Selecting any other number or key causes the counter to display "Error 03", which is displayed until either a valid instruction set is initiated or CLEAR DISPLAY is selected.

The band parameter controls the frequency measurement range. Select the appropriate band according to:

Band	Range
1	10 Hz to 100 MHz
2	10 MHz to 1 GHz
3	1 GHz to 20 GHz (25B) 1 GHz to 26.5 GHz (28B)

Keyboard Example:

PRESS: to select default band.

PRESS: to select Band 2.

GPIB Example:

Enter: OUTPUT 719;"B 2" to select Band 2.

- **FREQ OFFSET** - The FREQ OFFSET key initiates entry of a positive or negative decimal number to offset the measured frequency (to 1 Hz resolution). A number is input, and the instruction is terminated by selecting a units terminator (MHz or GHz). The OFS annunciator flashes until the instruction sequence is terminated and then remains lit for as long as the instruction is in effect. The display shows the last offset entered until entry of the first number of the new offset. The new offset is displayed as it is entered. Pressing either PWR METER key at this point causes the counter to display "Error 01", which is displayed until CLEAR DISPLAY is selected or until a valid instruction set is initiated. To exit this mode of operation, press the FREQ OFFSET key followed by the CLEAR DATA key.

Frequency offset allows the entry of a negative or positive frequency to 1 Hz resolution into the offset frequency register. This parameter controls the constant B in the formula:

$$\text{Displayed frequency} = (M \times \text{measured frequency}) \pm B$$

where M is the frequency multiplier and B is the frequency offset. Select frequency offset in the range of -99.999 999 GHz to +99.999 999 GHz. The number can be entered in any fixed-point format; the units terminator determines the scale of the input number.

Keyboard Examples:

PRESS: to select the default value.

PRESS: to select a 21.34 MHz value.

PRESS: to select a -0.12 GHz value.

GPIB Example:

Enter: OUTPUT 719;"FO 12.34 MHZ" to select a 12.34 MHz value.

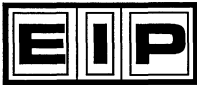



- **FREQ MULT** - The FREQ MULT key initiates entry of a positive integer, between 01 and 99, that is multiplied by the measured frequency. The second digit of the entered number terminates the instruction sequence. The MLT annunciator flashes until the sequence is terminated and then remains lit for as long as the instruction is in effect. The display shows the last multiplier until entry of the first digit of the new multiplier. The new multiplier is displayed until the instruction is terminated. To review current multiplier status, press the FREQ MULT key. The CLEAR DISPLAY key returns the counter to the multiplied and measured display. If both multiplier and offset functions are used, the counter displays the value derived from the following: (measurement x multiplier) \pm offset. To exit this mode of operation, press the FREQ MULT key followed by the CLEAR DATA key.

Frequency multiplier controls the value of the constant M in the formula:



$$\text{Display frequency} = (M \times \text{measured frequency}) \pm B$$

where M is the frequency multiplier and B is the frequency offset. The frequency multiplier must be an integer in the range of 01 to 99.

Keyboard Examples:

PRESS:   to select the default multiplier value.

PRESS:    to select a multiplier value of 7.

PRESS:    to select a multiplier value of 31.

GPIB Example:

Enter: OUTPUT 719;"ML 31" to select a multiplier value of 31.

- **RESOL** - The RESOL key is used to set the least significant digit of the display. Values of .1 (in Band 1 only) and integers 0 through 9 set the least significant digit as a power of 10 and terminate the instruction set as follows:

Resolution	Values
0.1 Hz	1
1 Hz	0
10 Hz	1
100 Hz	2
1 kHz	3
10 kHz	4
100 kHz	5
1 MHz	6
10 MHz	7
100 MHz	8
1 GHz	9

NOTE

When a value of .1 Hz is entered in Band 1, the significance of the digits on the front panel display is shifted left 3 digits. For example, a 9 MHz signal input is displayed as 9 GHz (see Figure 3-6). One digit is displayed to the right of the decimal, and the two right-most digits are blanked out. The display digit to the right of the decimal will be zero until the measurement is updated at the end of the 10 second gate interval. When changing bands, the resolution value is retained except when using a resolution of 0.1 Hz in Band 1. The new resolution, when switching to Band 2 or Band 3, is resolution 0.

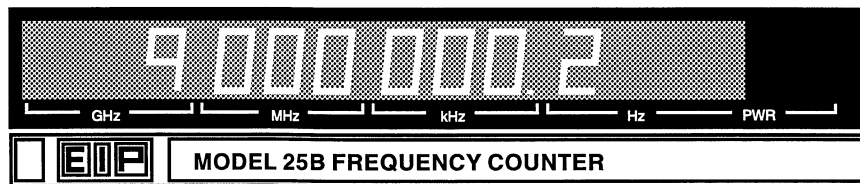

Figure 3-6. Measurement Display at 0.1 Hz Resolution (25B Shown).

Keyboard Examples:

PRESS: to select default resolution.

PRESS: to select resolution 2 (100 Hz).

PRESS: to select resolution .1 (0.1 Hz).

GPIB Examples:

Enter: OUTPUT 719;"R 4" to select resolution 4 (10 kHz).

Enter: OUTPUT 719;"R .1" to select resolution .1 (0.1 Hz).



- CENTER FREQ - The CENTER FREQ key is used to limit the counter's frequency search range in Band 3, and provides the following capabilities:

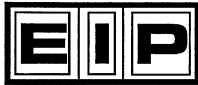

In an environment of multiple signals of equal amplitude (separated by as little as 40 MHz from 1 GHz to 20 GHz, or by as little as 60 MHz from 20 to 26.5 GHz), the counter will select and measure individual signals. The counter will also select and measure a signal among other higher amplitude signals, with the provision that signal separation be greater than 40 MHz. Once a signal is found and measured and the signal drifts out of the center frequency search range, the counter will track and measure the signal. The center frequency function also shortens the counter's signal acquisition time, thereby providing faster measurement results.





To initiate the center frequency feature, press the CENTER FREQ key, followed by the desired signal frequency (± 5 MHz) and a units key (MHz or GHz). The center frequency may be entered to a resolution of 1 MHz. To exit the center frequency mode, press the CENTER FREQ key followed by the CLEAR DATA key.

Keyboard Examples:

PRESS:   to select the default center frequency value.

PRESS:  1 4 . 8  to select a center frequency value of 14.8 GHz.

PRESS:  2 1 7 5  to select a center frequency value of 2175 MHz (2.175 GHz).

GPIB Example:

Enter: OUTPUT 719;"CF 14.8 GHZ" to select a center frequency of 14.8 GHz.

SIGNAL MEASUREMENTS

AUTOMATIC FREQUENCY MEASUREMENTS

To measure the frequency of a CW signal, apply the signal to the input connector that corresponds to the frequency being measured and select the appropriate band. The counter automatically finds the signal, measures it, and displays the measured frequency.

FREQUENCY MEASUREMENT IN A MULTIPLE SIGNAL ENVIRONMENT

In many applications, there is often more than one signal present. In a multiple signal environment, the counter automatically measures the frequency of the highest amplitude signal, within the limitations of the counter's amplitude discrimination specification. Amplitude discrimination is the ability of the counter to select, among multiple signals, the signal of highest amplitude.

Center Frequency

It is sometimes necessary to select and measure a lower amplitude signal among multiple signals. To meet this need, the counter provides a center frequency mode in Band 3. Figure 3-7 shows an example of the center frequency feature. If the signals shown in the figure are applied to Band 3, the counter would, in normal operation, select the signal at 6.2 GHz, since it is the highest amplitude signal. The center frequency mode makes it possible to select any of the signals shown. For example, to select the signal at 6.3 GHz, a center frequency of 6.3 GHz is entered. This limits the frequency search to a narrow range centered at 6.3 GHz, and prevents the counter from selecting either of the other two higher amplitude signals.

Frequency Limits

A lower amplitude signal among multiple signals may also be measured using the frequency limit low and frequency limit high functions. For instance, using the same signals as in the previous example, the lower amplitude signal at 6.3 GHz can be selected by setting a frequency limit low

of 6.25 GHz and frequency limit high of 6.35 GHz (see Figure 3-8). This confines the counter's signal search to a narrow range which prevents the counter from selecting either of the two higher amplitude signals.

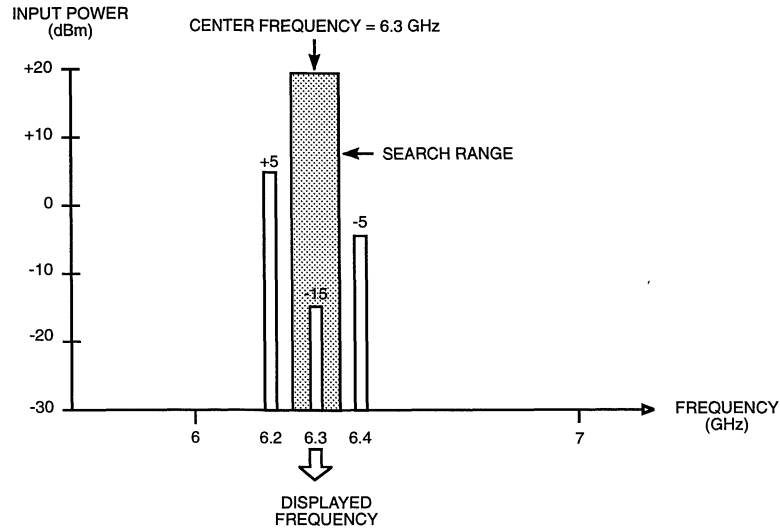

Figure 3-7. Center Frequency.

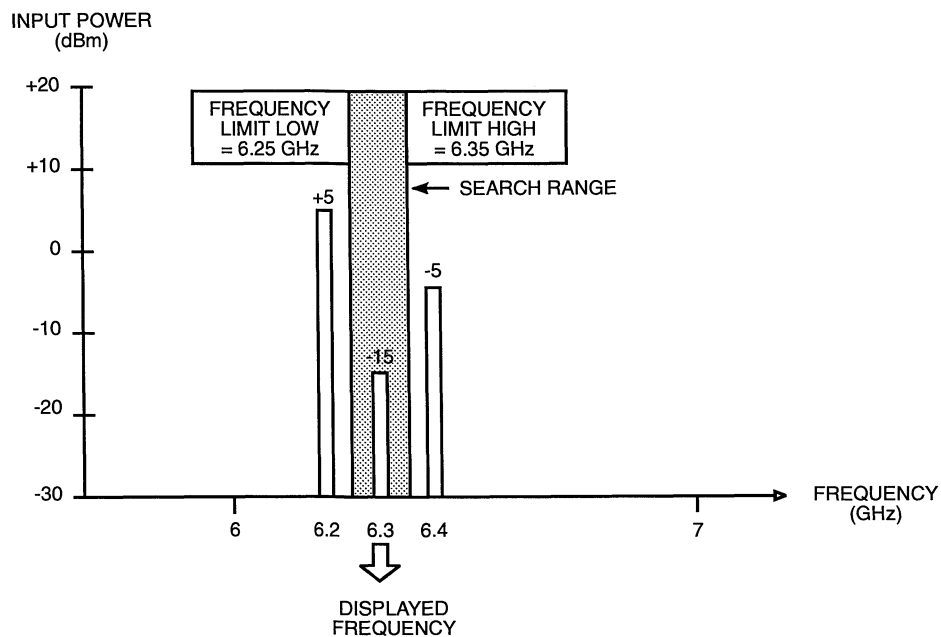
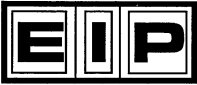

Figure 3-8. Frequency Limits.



COUNTER ACCURACY

When making any type of measurement, some degree of measurement error exists. In EIP CW counters, measurement error is a result primarily of the following two sources of error:

- time base error
- gate phasing error

TIME BASE ERROR

A frequency error in the time base oscillator results in a proportional error in the frequency measurement. An example would be the aging rate of the internal time base, specified to be less than 1×10^{-7} parts per month. This means that if the oscillator is set precisely on frequency at the beginning of a month, it could be as much as 1 Hz off at the month's end. On a frequency measurement of 18 GHz, a 1 Hz error in the 10 MHz time base would cause a measurement error of 1.8 kHz.

Time base error is a product of the following factors:

- temperature stability
- line variation
- aging rate
- short-term stability

Temperature stability refers to the variations in output frequency of an oscillator resulting from changes in ambient temperature. The counter's internal time base is a temperature compensated crystal oscillator (TCXO) with components that offset temperature-related frequency drift.

Line variation (fluctuation in applied ac power) causes changes in the voltage applied to the time base, which results in fluctuations in the oscillator frequency. The counter provides regulation to improve line stability and minimize time base frequency variance.

Aging rate is the long-term frequency drift that occurs in an oscillator, resulting from the inherent characteristics of the crystal.

Short-term stability refers to the ongoing random frequency fluctuations that occur in oscillator output. The primary cause of short-term frequency fluctuation is circuit noise.

GATE PHASING ERROR

Gate phasing error, the second source of measurement error, is caused by the relative timing of the gate and the arrival of the signal to be counted. This results in an uncertainty of ± 1 count in the least significant digit of the measurement. For example, if the counter resolution is set to 1 kHz, then the potential error on each gate is ± 1 kHz. Figure 3-9 illustrates gate phasing error. The incoming signal, after passing through the signal conditioner, appears at the main gate as a pulse train. Gate B, though the same width as Gate A, counts three events (pulses corresponding to signal zero-crossings) while Gate A counts only 2.

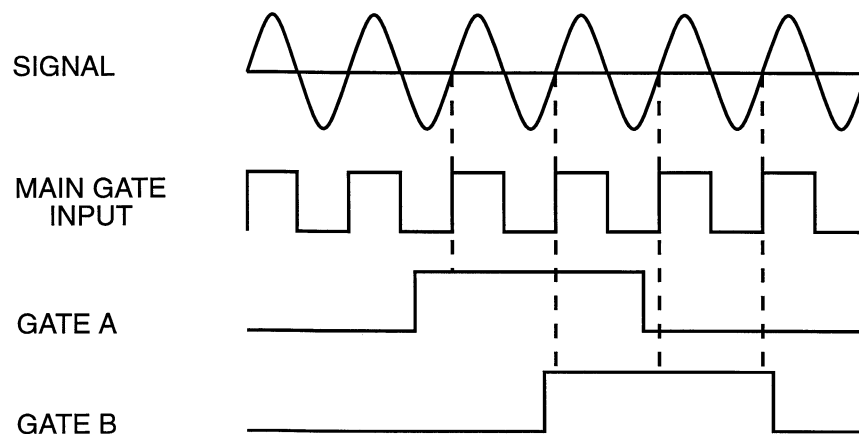

Figure 3-9. Gate Phasing Error.

TECHNIQUES FOR IMPROVING ACCURACY

In most cases, the specified accuracy of the EIP 25B/28B counters will be more than sufficient to meet measurement requirements. Greater accuracy, if required, can be achieved by minimizing error in the time base, since this is the primary source of measurement error.

Temperature effects on the time base are minimized by calibrating the time base at the temperature at which the counter will be used, using a time base of higher accuracy. Long-term frequency drift can be minimized by frequent calibration of the time base. Finally, an external time base with a higher degree of accuracy can be used, such as a 10 MHz oven oscillator, or a rubidium or cesium beam frequency standard.

CALCULATING MEASUREMENT ERROR

Following are sample calculations for determining the measurement error of the counter, based on the time base aging rate.

Given: Aging rate: 1×10^{-7} /month
 Calibration interval: 6 months
 Frequency: 20 GHz

Calculation: Error = \pm (aging rate x cal. interval x frequency)

$$\begin{aligned}
 &= \pm \left(\frac{1 \times 10^{-7}}{\text{mo.}} \times 6 \text{ mo.} \times 2 \times 10^{10} \text{ Hz} \right) \\
 &= \pm (6 \times 10^{-7} \times 2 \times 10^{10} \text{ Hz}) \\
 &= \pm (12 \times 10^3 \text{ Hz}) \\
 &= \pm 12 \text{ kHz}
 \end{aligned}$$

Counter measurement, after a six-month calibration interval, could have an error of ± 12 kHz in measuring a 20 GHz signal.



Given: Aging rate: 1×10^{-7} /month
 Calibration interval: 12 months
 Frequency: 20 GHz

Calculation: Error = \pm (aging rate x cal. interval x frequency)

$$= \pm \left(\frac{1 \times 10^{-7}}{\text{mo.}} \times 12 \text{ mo.} \times 2 \times 10^{10} \text{ Hz} \right)$$

$$= \pm (12 \times 10^{-7} \times 2 \times 10^{10} \text{ Hz})$$

$$= \pm (24 \times 10^3 \text{ Hz})$$

$$= \pm 24 \text{ kHz}$$

Counter measurement after the recommended 12-month calibration interval could have an error of ± 24 kHz in measuring a 20 GHz signal.

These examples are for illustrative purposes only. Actual calculations of measurement error must include the other sources of time base error, as well as gate phasing error.

POWER METER

DESCRIPTION

The power meter measures the power level of signals applied to the BAND 3 input. The power level is measured in dBm and displayed simultaneously with the frequency. The front panel PWR METER ON/OFF key activates/deactivates the power meter. The power meter can also be controlled via the GPIB interface. Using the PWR METER OFFSET key, power offsets can also be entered in the range from -99.9 dB to 99.9 dB at a resolution of 0.1 dB.





When the power meter is activated, the three right-most digits on the front panel will display the power measurement results to a resolution of 0.1 dB. To indicate the units of measure, the dBm annunciator is lit when the power meter is active. If no signal is input to Band 3 while the power meter is active, the display will read "EE.E".



For AM and FM averaging purposes, gate time is controllable in the power meter mode via the resolution function. The power measurement gate time matches the frequency gate measurement gate time. For example, with a counter resolution of 0, both the frequency measurement gate time and the power measurement gate time are 1 second.

Keyboard Examples:

PRESS:  to activate/deactivate power meter.

PRESS:  to activate the power offset function.

PRESS:     to set a power offset of 10 dB.

PRESS:   to terminate power offset function.

GPIB Examples:

Enter: OUTPUT 719;"PA" to turn on the power meter.

Enter: OUTPUT 719;"PP" to turn off the power meter.

Enter: OUTPUT 719;"OA" to enable offsets.

Enter: OUTPUT 719;"OP" to disable offsets.

Enter: OUTPUT 719;"PO 10 DB" to set a power offset of 10 dB.

Enter: OUTPUT 719;"PO 01 DB" to clear a power offset.

SPECIAL FUNCTIONS DIRECTORY

Counter special functions can be divided into two categories:

1. Counter operation verification
2. Calibration/troubleshooting aids

ACTIVATION OF SPECIAL FUNCTIONS

CAUTION



Executing either Special Function 10 or 91 can cause a loss of calibration data. To prevent this from occurring, access to these functions is blocked by an internal memory protect feature. Attempting to access these functions with the memory protected will cause the counter to display "Error 20". See the service manual for information on unprotecting the memory.

Special functions can be activated through both the front panel keyboard and the GPIB interface. To activate a special function through the keyboard, press the SPECIAL FUNC key followed by two digit keys. To activate a special function through the optional GPIB interface, enter "TA dd", where dd is a two-digit special function number. Activating special functions will not alter any previously entered parameters unless specifically stated. To terminate all previously activated special functions in local mode, press the CLEAR DISPLAY key. To terminate all special functions using GPIB, issue the command TP.

OPERATION VERIFICATION FUNCTIONS

Special Functions numbered 01 through 05 provide the user with a means of verifying that the counter is operational.

SPECIAL FUNCTION 01: 200 MHz Self-Test

This function is used to verify that the Count Chain, Gate Generator, and the VCO are operational.

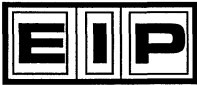

When this function is entered, the counter will do the following:

1. Exit the current band.
2. Set the hardware to the self-test mode.
3. Set the VCO to 400 MHz.
4. Set the counter to take frequency measurements only.
5. Begin frequency measurements.

The display will show the frequency measurement results. These results will also be output to the GPIB interface when frequency readings are requested. The measurement result should be 200 MHz \pm 1 count.

SPECIAL FUNCTION 02: Light Display Segments Test

This function will light all LEDs, annunciators, and decimal points. It is used to verify that all displays light, to check the intensity of the display, and to align the LEDs and annunciators.

SPECIAL FUNCTION 03: Scan Display Segments Test

This function lights each segment of every digit and each annunciator in every bank sequentially. The cycle rate can be adjusted with the sample rate control. It is used to verify that each segment of the display, each segment driver, and the display multiplexer operates properly and independently.

SPECIAL FUNCTION 04: Scan Display Digits Test

This function lights all segments of each digit and its decimal point simultaneously. The test cycles through all digits and annunciators. The cycle rate is determined by the sample rate control. It is used to check each digit and digit driver independently, and verifies operation of the display multiplexer.

SPECIAL FUNCTION 05: Keyboard Test

This function is used to verify the operation of the keyboard.

After this function is activated, the counter stops normal operation. After the next key is pressed, the display shows "C dd" where dd is the two-digit code of that key. When a new key is pressed, the display is updated to show the code of the new key. When the GPIB controller requests a key code, the code of the last key pressed is output. (If the controller requests a key code, the counter will output to the GPIB interface the code of the last key pressed even if Special Function 05 is not activated). If the counter is in local mode, this function must be terminated by the CLEAR DISPLAY key. If it is in remote, this function can be terminated by any device-dependent command.

Key	Code
±/FREQ OFFSET	21
7/SAMPLE RATE DOWN	22
8/SAMPLE RATE HOLD	23
9/SAMPLE RATE UP	24
GHz	25
CLEAR DATA	26
./FREQ MULT	31
4/CENTER FREQ	32
5/FREQ LIMIT LOW	33
6/FREQ LIMIT HIGH	34
MHz/dB	35
CLEAR DISPLAY	exits test
0/RESET LOCAL	11
1/BAND	12
2/RESOL	13
3/SPECIAL FUNC	14
PWR METER ON/OFF	15
PWR METER OFFSET	16

TROUBLESHOOTING FUNCTIONS

SPECIAL FUNCTION 06: Converter Ramp Test

This function continuously ramps the Band 3 Converter DAC through its range. It is used to test the YIG DAC, YIG driver, YIG, and Band 3 RF level circuits.

SPECIAL FUNCTION 07: Sweep VCO Test

This function cycles the VCO from 400 to 500 MHz in increments of 50 kHz. The cycle rate can be adjusted using the sample rate control. It is used to test the VCO and phase lock circuitry.

SPECIAL FUNCTION 08: Power Meter Offset Test

This function sets the power meter zero DAC. The setting is entered as a four-digit hexadecimal number. The first two digits are used to program the coarse offset DAC, and the last two digits program the fine offset DAC. Special Function 08 enables the power meter zero DAC to be tested, and provides a DC level signal to aid in troubleshooting power meter circuitry.

SPECIAL FUNCTION 09: Power Meter Gain Test

This function sets the power meter sensing circuit to a selected number. The number is entered as a five-digit hexadecimal number in the following format:

1st digit	A107U10 bits 4-7
2nd digit	A107U10 bits 0-3
3rd digit	A107U12 bits 4-7
4th digit	A107U12 bits 0-3
5th digit bit 0	Sets Amp marked "15 dB Gain" to high gain.
5th digit bit 1	Sets Amp marked "30 dB Gain" to high gain.

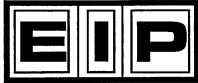

Digit 5 is a 2-bit number, so any number entered for digit 5 will be justified to a number from 0-3. Special Function 09 tests the RF level and power meter circuits.

SPECIAL FUNCTION 10: Display/Alter Memory

Special Function 10 reads the microprocessor address and, if that address is RAM or I/O, can change its contents. The desired address is entered as a 4-digit hexadecimal number. When the 4th digit is entered, the counter displays the contents of the entered address. The contents can then be changed by entering a two-digit hexadecimal number.

CAUTION



Executing Special Function 10 can cause a loss of calibration data. To prevent this from occurring, access to this function is blocked by an internal memory protect feature. Attempting to access this function with the memory protected will cause the counter to display "Error 20". See the service manual for information on unprotecting the memory.

SPECIAL FUNCTION 20: Select External Reference

This function configures the counter to external time base reference input mode.



SPECIAL FUNCTION 21: Select Internal Reference



This function configures the counter to internal time base reference input mode.

SPECIAL FUNCTION 90: Display and/or Alter GPIB Address

When this function is activated, the counter displays the current address of the GPIB interface. If the address does not need to be changed, the function can then be terminated by pressing the CLEAR DISPLAY key.

After this function has been activated, the GPIB address can then be changed by entering a two-digit number between 01 and 99, inclusive.

PRESS:    to display current GPIB address.

PRESS:   to set the GPIB address to 19.

PRESS:  to exit this function.

SPECIAL FUNCTION 91: YIG DAC Automatic Calibration

This function is used to calibrate the Band 3 input filter. Refer to the service manual for complete information

CAUTION



Executing Special Function 91 can cause a loss of calibration data. To prevent this from occurring, access to this function is blocked by an internal memory protect feature. Attempting to access this function with the memory protected will cause the counter to display "Error 20". See the service manual for information on unprotecting the memory.

MUTUALLY EXCLUSIVE FUNCTIONS

1. When the 200 MHz self-test (Special Function 01) is active, all other counter functions are inactive with the exception of the resolution function. If any key is pushed when the counter is in self-test, the test is exited.
2. The power meter function is terminated whenever BAND 1 or 2 is selected.



ERROR MESSAGES

When an error occurs, the error number is displayed. The probable cause of each error is listed below.

- 01 Invalid key sequence.
- 02 A resolution number was not entered.
- 03 A band number was not entered, or the number entered was too large.
- 04 No power reading in current band.
- 05 Frequency limit high >20.5 GHz (27 GHz in model 28B).
- 06 (Freq Limit Hi) - (Freq Limit Lo) <100 MHz.
- 07 Frequency Limit Low <.95 GHz (25B/28B).
- 09 Illegal special function key sequence.
- 13 Option not installed.
- 19 Function not allowed in 0.1 resolution.
- 20 Access to this function blocked by memory protect switch.
- 30 EEPROM error.
- 31 Check sum error Section 1 PROM
- 32 Check sum error Section 2 PROM
- 33 Check sum error Section 3 PROM
- 40 DAC table error, cannot find YIG frequency.
- 41 Calibration frequency error.
- 42 Signal not found.

4

PROGRAMMING

INTRODUCTION

The GPIB interface of the 25B/28B counters is fully compatible with the IEEE 488-1978 standard. With the GPIB interface, the counter can respond to remote control instructions and can output measurement results via the IEEE 488-1978 Bus interface. At the simplest level, the counter can output data to other devices such as a thermal printer. In more sophisticated systems, an instrument controller can remotely program the counter, trigger measurements, and read results.

GPIB FUNCTIONS IMPLEMENTED

The GPIB interface function subsets implemented are as follows:

Interface Function	Subset	Description
Source Handshake	SH1	complete capability
Acceptor Handshake	AH1	complete capability
Talker	T5	basic talker, serial poll, Talk Only mode, unaddress if MLA
Listener	L3	basic listener, Listen Only mode, unaddress if MTA
Service Request	SR1	complete capability
Remote Local	RL1	complete capability
Device Clear	DC1	complete capability
Device Trigger	DT1	complete capability

REMOTE/LOCAL FUNCTION

When the counter changes from local mode to remote mode or vice-versa, all the stored information is retained. The counter will operate in the same state as it was before the change. The only exception is that when a special function is active, the special function is automatically terminated. When the counter is in remote and LOCAL LOCKOUT is not active, pressing the RESET LOCAL key on the front panel keyboard returns the counter to local mode.



NOTE

In local mode, the speed of the counter's measurement cycle is controlled via the SAMPLE RATE keys on the front panel. In remote mode, the front panel controls are disabled and the speed of the counter's measurement cycle is under software control. Refer to the GPIB FAST ACTIVE/PASSIVE and HOLD ACTIVE/PASSIVE commands for additional information.

DEFAULT STATE (DEVICE CLEAR FUNCTION)

When the GPIB command DEVICE CLEAR or SELECTED DEVICE CLEAR is received, the counter will revert to its power-on state. The following is a list of the factory-set default values of the major counter parameters.

Parameter	Default Value
Band	3
Center frequency	0
Display	Enabled
Exponent	0
External reference	Off
Fast	Passive
Frequency limit high	20.5 GHz (26.7 GHz for 28B)
Frequency limit low	950 MHz
Frequency multiplier	01
Frequency offset	0
Hold	Passive
Power meter	Off
Resolution	0 (1 Hz)
Sample rate	50 ms
Service request	Passive
Special functions	Inactive

DEVICE TRIGGER FUNCTION

When the GPIB bus command DEVICE TRIGGER is received, the counter will initiate a new frequency reading cycle. The converter will not be reset. If the counter does not have a converter lock, the DEVICE TRIGGER will not be performed until a converter locked condition exists.

GPIB ADDRESS SELECTION

This counter employs a software selectable GPIB address which is stored in non-volatile memory. To verify the GPIB address, activate Special Function 90: the counter will display the current GPIB address. Press the CLEAR DISPLAY key to exit Special Function 90 without changing the GPIB address.

To change the GPIB address, select Special Function 90 followed by the desired GPIB address (see Figure 4-1 for list of allowable GPIB address codes).

For example:

PRESS: to select GPIB address 20.
FUNC DISPLAY

Since the GPIB address is stored in non-volatile memory, the counter will always default to the last GPIB address selected. The GPIB address selection is also used to put the counter in the Talk Only or Listen Only mode. To put the counter in the Listen Only mode, simply set the GPIB address to 41 or higher.

TALK ONLY MODES

The talk only modes enable the counter to output data to other devices on the bus, such as a printer, without the need of an instrument controller. To use the counter in a talk only mode, enter the GPIB address corresponding to the desired sample rate and output format as follows:

Address	Sample Rate	Exponent Format
32	Controls enabled	Scientific
33	Fast active - controls disabled	Scientific
34	Controls enabled	Zero output
35	Fast active - controls disabled	Zero output

NOTE

In the Talk Only or the Listen Only mode, the address of the counter is always automatically set to decimal 0.

GPIB INSTRUCTION FORMAT

<OP CODE> <NUMBER> <TERMINATOR>

OPERATION CODE or OP CODE can take any of the following formats:

<LETTER> <LETTER> or <LETTER> <DIGIT>
 Example: FH (Frequency Limit High) or B3 (Band 3)

The NUMBER portion of the statement can take the form of any of the following:

<SIGN> <DIGIT STRING>
 Example: -2457
 <SIGN> <DIGIT STRING> . <DIGIT STRING>
 Example: -3.483

NOTE

Spaces within the <OP CODE> and <NUMBER> and between the <OP CODE> <NUMBER> and <TERMINATOR> portions of the instructions are optional and are always ignored. In GPIB program examples, spaces are used to aid in program readability.



The TERMINATOR allows the operator to choose the scale of an input number as well as implement special functions.

TERMINATOR = G/M/K/H/D/P/C

G, M, K, H, represent GHz, MHz, kHz, and Hz, respectively.

D = dB, P = clear data, (equivalent to "CLEAR DATA" key on keyboard)

C = clear display (equivalent to "CLEAR DISPLAY" key on keyboard)

FORMAL DEFINITION OF INSTRUCTIONS

<OP CODE> <NUMBER> <TERMINATOR>

<OP CODE> ::= <LETTER> <LETTER> | <LETTER> <DIGIT>

<NUMBER> ::= <SIGN> <DIGIT STRING> | <SIGN> <DIGIT STRING> . <DIGIT STRING> | NULL

<TERMINATOR> ::= G | M | K | H | D | P | C | NULL

<SIGN> ::= + | - | NULL <DIGIT STRING> ::= <DIGIT> <DIGIT> <DIGIT>

<LETTER> ::= A | B | C | D | E | F | G | H | I | J | K | L | M | N | O | P | Q | R | S | T | U | V | W | X | Y | Z |

<DIGIT> ::= 1 | 2 | 3 | 4 | 5 | 6 | 7 | 8 | 9 | 0

DESCRIPTION OF AVAILABLE COMMANDS

DISPLAY

DA - Display Active - Outputs readings to both front panel and GPIB bus.

DP - Display Passive - Outputs readings to GPIB bus only. It will decrease the cycle time of the counter.

DN - Display Normal - Resets display only; used for clearing error messages on the display. Cannot be used after verifying preprogrammed data such as frequency offsets or frequency limits. This command affects only the display.

BAND

B1 - Selects Band 1

B2 - Selects Band 2.

B3 - Selects Band 3.

RESOLUTION

R.1 thru R9 - Resolution .1 thru 9 - Selects the front panel resolution from .1 Hz to 1 GHz. Also chooses gate time which is related to resolution: .1 Hz = 10 s, 1 Hz = 1 s, 10 Hz = 100 ms, 100 Hz = 10 ms, and 1 kHz to 1 GHz = 1 ms.

MEASUREMENT FUNCTIONS

FA - Fast Active - Causes the counter to go into the fast cycle mode of operation. In this mode, the front panel SAMPLE RATE controls are disabled and the fastest sample rate is attained. The counter will not go into the Fast Active mode of operation if Hold Active is enabled.

FP - Fast Passive - Terminates FA mode. Front panel SAMPLE RATE controls are enabled. The sample rate reverts to the rate selected in local mode prior to activation of Fast Active mode.

RS - Reset basic counter and converter - Reacquires input signal and performs a new measurement. Has the same function as the front panel RESET LOCAL key when in local mode.

HA - Hold Active - The counter stops performing measurements and the last frequency and power measurement results are displayed and held. The counter can be directed to make a single measurement when it is in this mode by sending Device Trigger or Selected Device Trigger GPIB bus command to the counter. It will also update the measurement results if the RS mnemonic is received.

HP - Hold Passive - Terminates HA.

DATA MANIPULATION FUNCTIONS

FO - Frequency Offset - Enables entry of frequency offsets to 1 Hz resolution. A new gate will be initiated after data entry if counter is not in hold.

PO - Power Offset

OA - Offset Active - Adds the frequency offset to frequency measurement results. Adds the power offset to power measurement results if power meter function is active.

OP - Offset Passive - Does not add frequency and power offset to measurement results.

ML - Multiplier - Enables entry of a 2-digit frequency multiplier. The multiplier must be an integer between 00 and 99. The results are to 1 kHz resolution. A new measurement will be initiated after the data entry if the counter is not in hold. If the results of the multiplications are larger than or equal to 999.999,999,000 GHz, the counter will output 999.999,999,000 GHz to the bus if asked to output measurement results.

POWER METER

PA - Power Meter Active - Turns on the power meter measurement function.

PP - Power Meter Passive - Turns off the power meter measurement function.

FREQUENCY LIMITS

FH - Frequency Limit High - Enables entry of frequency limit high to 10 MHz resolution. Sets the high frequency limit searched by the counter in Band 3. The basic counter and converter will be reset after the data entry.

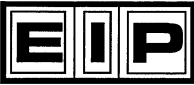

FL - Frequency Limit Low - Enables entry of frequency limit low to 10 MHz resolution. Sets the low frequency limit searched by the counter in Band 3. The basic counter and converter will be reset after the data entry.

CF - Enables entry of a center frequency to 1 MHz resolution. Limits the frequency search range of the counter in Band 3.

SPECIAL FUNCTIONS

TA - Test Active - Enables the counter to perform a specified special function by entering TA followed by the two-digit special function number. When Special Function 05, 08, 09, or 10 is active and the counter is being asked to output data, the data that is displayed on the front panel is the data being output.

The output data format is as follows:

```
XXXXXXXXXXXXCRLF
X      = alpha-numeric
CR     = carriage return
LF     = line feed
```

For detailed descriptions of Special Functions 01 through 09 and 11, see the special functions directory.

TP - Test Passive - Terminates the specified special function by entering TP followed by the two-digit special function number.

DATA FORMAT

EZ - Exponent Zero - output format.

ES - Exponent Scientific - output format.

DATA OUTPUT

BR - Enables output of both frequency and power measurement results. (See section on data output format.)

FR - Enables output of frequency measurement results only. (See section on data output format.)

PR - Enables output of power measurement results only. (See section on data output format.)

DAC OPTION

DC - Enables the DAC option. Enter DC followed by two decimal digits which correspond to the location of the most significant digit in the three digits desired. To turn the DAC option off, input DC00 or DCP.

DC00 - turns DAC option off
 DC02 - selects 1 Hz digit
 thru
 DC12 - selects 100, 10, and 1 GHz digits

SERVICE REQUEST

SR - Service Request Enable - Enables the counter to send a Service Request to the bus when any ORed combination of bits in the status byte are set. The bit values correspond to the internal status of the counter, as shown in Figure 4-2. To enable the function, input SR followed by two decimal digits. The two digits are the weighted sum of the bits that are set in the status byte. To disable the Service Request function, input SR00.

NOTE

Even when the Service Request function is disabled, the Service Request status byte will still be continuously altered to reflect the internal states of the counter.

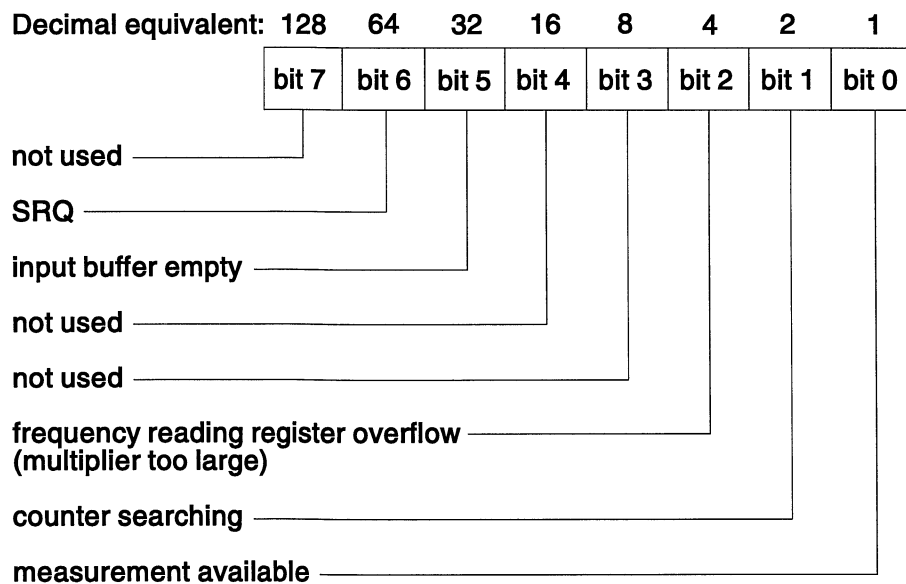

Figure 4-2. Status Byte Structure.

SERVICE REQUEST MASK

The counter can be instructed to send an interrupt, by setting the SRQ line on the GPIB, when any ORed combination of the bits in the status byte are set. This is done by sending the counter a service request mask.

For example, to instruct the counter to generate an SRQ on measurement available OR input buffer empty, send the following service request mask:

OUTPUT 719;"SR33"

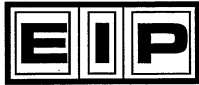

This would tell the counter to generate an SRQ whenever bit 0 or bit 5 of the status byte are set. Since bit 0 corresponds to measurement available and bit 5 corresponds to input buffer empty, the counter would generate an SRQ whenever either the input buffer was empty or a measurement was available.

The following items should be included in any program using the SRQ feature:

1. Tell the counter when to generate an SRQ. That is, tell the counter which events should generate an SRQ. This is done using the SRQMASK command.
2. Tell the controller to monitor the SRQ line on the GPIB. The SRQ is a maskable interrupt and the controller needs to know if it should respond to the interrupt.
3. Tell the controller what to do when it receives an SRQ interrupt.
4. Serial Poll the counter after an SRQ is generated to clear the interrupt. When the counter generates a SRQ it sets bit 6 in the status byte. Serial polling the instrument clears the SRQ bit and allows the instrument to generate a new SRQ upon the next occurrence of the conditions specified in the SRQ Mask.
5. It may also be necessary to clear the SRQ register in the controller. Consult your manual on the controller for more information on clearing the SRQ register in the controller.

The following program, written on a HP-85, demonstrates how to use the SRQ feature to obtain a valid measurement from the counter.

```
10   ASSIGN @COUNTER TO 719   ! Assigns 719 to address variable
                                ! The number 7 is the GPIB interface
                                ! and 19 is the counters GPIB address
20   REMOTE @COUNTER          ! Place counter in remote mode
30   OUTPUT @COUNTER;"SR01"  ! Send SRQ mask to counter
40   ENABLE INTR 7;2        ! Enable interrupt in controller
50   ON INTER 7 GOTO FLAG! Tell controller how to handle interrupt
60   PRINT "WAITING FOR VALID MEASUREMENT"
70   WAITING:              ! Label
80   GOTO WAITING
90   FLAG: PRINT "***** SRQ RECEIVED *****"

100  ENTER @COUNTER;FREQ      ! Input Frequency from counter
110  PRINT "FREQ " = ;FREQ    ! Print Frequency
120  S2 = SPOLL(@COUNTER)    ! Clear SRQ bit in counter
130  STATUS 7,4;S           ! Clear SRQ bit in controller
140  OUTPUT @COUNTER;"SR00"  ! Turn off SRQ mask in counter
150  OFF INTR 7             ! Turn off interrupt in controller
160  END                    ! Program end
```

To demonstrate this program, set up counter with no signal applied and run the program. The controller should continually print out "WAITING FOR VALID MEASUREMENT". Then apply a signal. As soon as the counter finds the signal and counts it, the controller will output the frequency measurement results.

DATA OUTPUT FORMAT

To output measurement results, the 25B/28B transmits the following string of characters:

Format

```

EZ (Exponent Zero)  b ± D D D D D D D D D D D D D E 0 CR LF
ES (Exponent SCI)* ± D D D D D D D D D D D D D D E D CR LF
Power**            b b b b b b b b b b ± D D D . D CR LF
    
```

Freq. + Power

```

FREQ in EZ mode:  b ± D D D D D D D D D D D D D E 0, b b b b b b b b b b ±
                  D D D . D CR LF
FREQ in ES mode:  ± D D D D D D D D D D D D D D E D, b b b b b b b b b b ±
                  D D D . D CR LF
    
```

When the counter is in Special Function 05, 08, 09, or 10, the output will reflect the data on the display. The format is as follows:

```

XXXXXXXXXXXXCRLF.
b = Blank
D = Digit
X = Alpha-numeric Character
CR = Carriage Return
LF = Line Feed
    
```

* In Exponent Scientific mode, one digit represents the position of the decimal point. The exponent digit can be either 0, 3, 6, or 9.

** For power data, the output resolution is fixed at 0.1 dB.

Under different output modes, the following counter outputs can be expected by a listener.

Data Output Mode	Counter Operating Mode	Output
BR	PA PP TA01	FREQ = PWR FREQ FREQ
FR	PA PP TA01	FREQ FREQ FREQ
PR	PA PP TA01	PWR -999.9 -999.9
BR, FR or PR	TA05, 08, 09, or 10	Data on front panel display

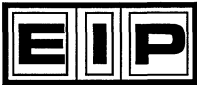

PROGRAM EXAMPLE

The following measurement conditions are set by addressing the counter to listen and then sending the following character string:

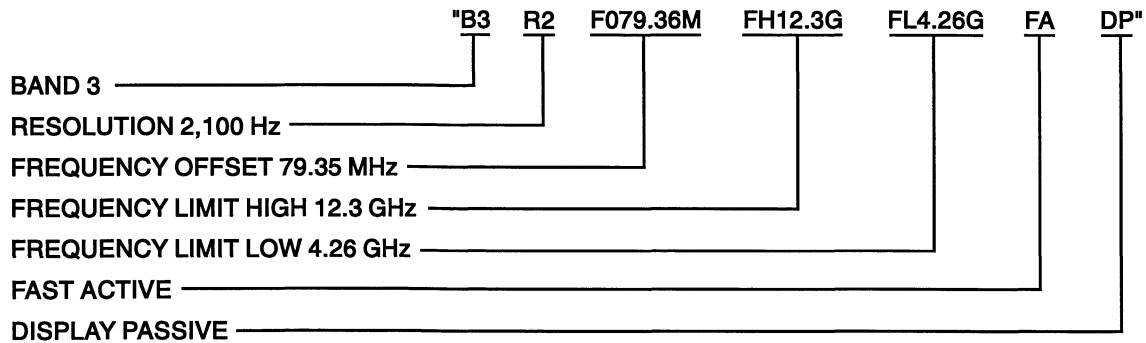

READING MEASUREMENTS

The EIP counters provide a choice of methods for reading measurements. The HOLD ACTIVE or HA mode takes one reading and then waits for a RESET command or a device trigger GPIB command. In this condition, the counter is sent a RESET or device trigger and (when addressed to talk) a new reading is output to the bus. The counter will hold that particular reading on the display until another RESET command or device trigger command is received. The second mode is HP or HOLD PASSIVE. In this mode, data is read out to the bus in the normal way. The display is automatically updated according to the sample rate chosen. In this condition, successive readings can be output without generating a RESET or device trigger command each time.

INPUT SPEED

It takes a specific amount of time for the counter to process the input data (due to error checking, formatting, changing the mode of operation, etc.). To prevent the data rate of the bus from slowing down while the counter is processing input data, the data is accepted as soon as it is available on the bus and is temporarily stored in memory. The size of the storage memory is 100 characters.

Using the GPIB interface, there is a need to be aware of the difference between accepting data and complying with it. If the counter is asked to output a reading before it has finished processing the input data, the output will not reflect the newly entered data. To prevent this, sufficient programmed delays must be provided (see the program examples on page 4-12). Use can also be made of the counter's Service Request status byte. Bit 5 in the status byte can be used to determine if the counter has completed the processing of GPIB command messages. For more information, see the Service Request (SR) command description.

5

OPERATIONAL VERIFICATION TESTS

INTRODUCTION

This section contains test procedures that are used for verifying proper operation of the counter. Although these tests are not comprehensive, they do insure, to a high degree of confidence, that the instrument is operating properly. The tests can be useful for incoming inspection and should be performed after any servicing to insure proper operation of the counter. All tests can be performed without removing the instrument covers. A test report form that can be used to provide a test record is included at the end of this section. If the test application is especially critical in nature, more extensive testing of the counter may be required. See the Performance Verification Test section in the service manual for more information.

EQUIPMENT REQUIREMENTS

Equipment required for the operational verification tests on the EIP 25B or 28B counter is listed in Table 5-1. The critical parameters are the minimum use specifications required for the performance of the procedures, and are included to assist in the selection of alternative equipment. Satisfactory performance of alternative items should be verified prior to use. All applicable equipment must bear evidence of current calibration. For some of the following tests, an EIP 28B counter is used to source lock the microwave sweeper, thus providing a stable source for testing. This combination may be replaced by a frequency synthesizer.

Table 5-1. Equipment Requirements.

Description	Critical Parameters	Recommended Manufacturer	Model
Synthesized function generator	10 Hz to 10 MHz	Wavetek	23
Sweep generator	10 MHz to 26.5 GHz	Wiltron	6668B
Sweep generator	3 GHz to 18 GHz	Wiltron	6635A
Source locking counter	10 MHz to 26.5 GHz	EIP	578B
Spectrum analyzer	3 GHz to 18 GHz	Hewlett Packard	8566B
Power meter	10 MHz to 26.5 GHz	Hewlett Packard	437B
Power sensor	10 MHz to 1 GHz (-15 dBm)	Hewlett Packard	8481A
Power sensor	1 GHz to 26.5 GHz (-20 dBm)	Hewlett Packard	8485A
Oscilloscope	DC to 100 MHz	Tektronix	475
Power splitter	10 MHz to 26.5 GHz	Hewlett Packard	11667B
50 ohm termination		Pomona	4119-50

SOURCE LOCKING SETUP

In some of the following tests, the EIP 578B counter is used to source lock the sweep generator to provide a stable frequency source for testing the 25B/28B counters.

The source locking setup, described below, is not limited to locking the Wiltron sweeper. It can be used to source lock almost any electronically tunable signal source over a frequency range of 10 MHz to 110 GHz. For more information on source locking the Wiltron 6600 series of sweep generators, request Application Bulletin 10 from our sales representative in your area or directly from EIP.

Regardless of the particular sweeper, the procedure for source locking is basically the same. A sample of the output from the sweeper is applied to the appropriate band on the EIP 578B counter. For the setup shown in Figure 5-1, a power splitter provides the sample. The COARSE TUNE OUT connector from the 578B counter is connected to the external sweep input on the sweeper. The \emptyset LOCK OUT connector on the 578B counter is connected to the FM input on the sweeper. The FM modulation on the sweeper is enabled and the sweeper is set to the external sweep mode.

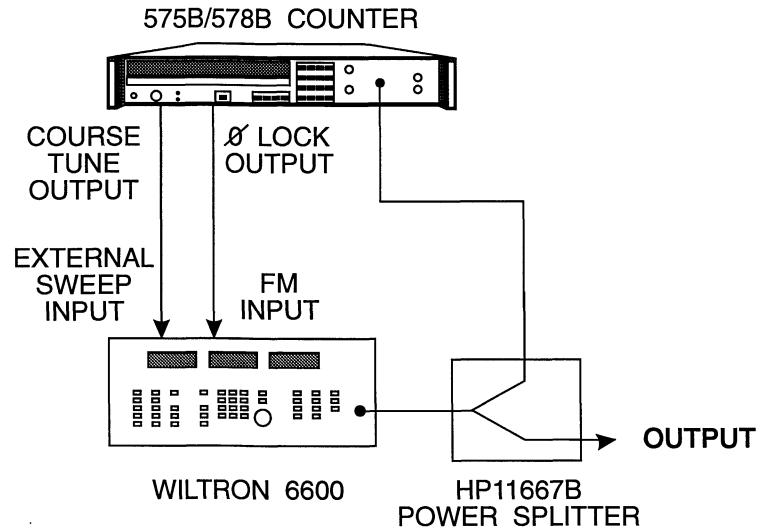

Figure 5-1. Source Locking Setup.

With the equipment set up as described above, source locking over the entire range of the sweeper can be achieved by entering the desired frequency.

For example, to lock the sweeper at 10 GHz:

PRESS:
FREQ

At this point, the sweeper should be locked at 10 GHz, the LCK annunciator on the counter should be lit, and 10 GHz should be the displayed frequency. In the following tests, the output frequency from the sweeper is controlled directly by the EIP 578B counter, while the power is controlled at the sweeper.

OPERATIONAL VERIFICATION TEST PROCEDURES

BAND 1 RANGE AND SENSITIVITY TEST (10 Hz to 10 MHz)

Description

This test verifies counter operation from 10 Hz to 10 MHz at 25 mVrms (70.7 mV p-p into 50 ohms). The oscilloscope is used to set signal levels.

Equipment

Synthesized function generator (Wavetek 23)
 Oscilloscope (Tektronix 475)
 50 ohm termination (Pomona 4119-50)

Test Setup 1

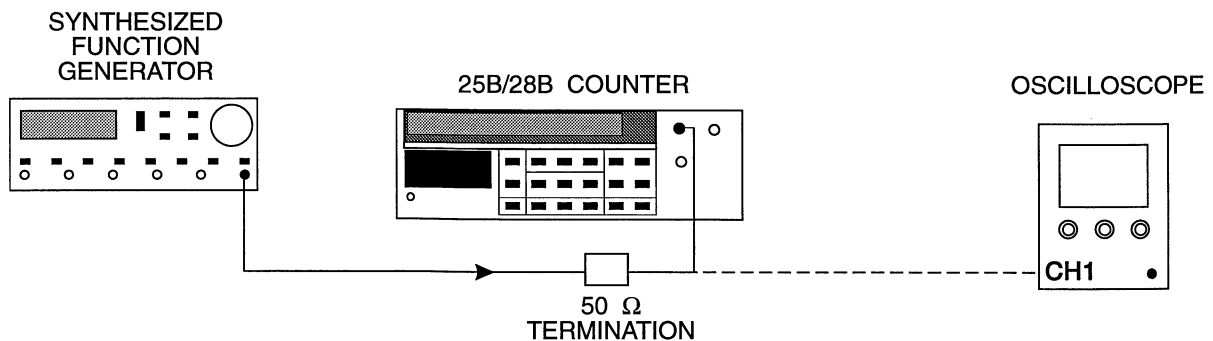

Figure 5-2. Band 1 Range and Sensitivity Test Setup (10 Hz to 10 MHz).

Procedure

1. Connect equipment as shown in Figure 5-2.
2. Set the counter to Band 1 and select resolution 2.
3. Set the output frequency from the synthesizer to 10 Hz.
4. Using the oscilloscope, set the output signal level from the synthesizer to 25 mVrms (70.7 mV p-p into 50 ohms).
5. Apply the 10 Hz signal to the counter, verify proper reading, and record the results.
6. Repeat steps 3, 4, and 5 at 100 Hz, 1 kHz, 10 kHz, 100 kHz, 1 MHz, and 10 MHz.

BAND 1 RANGE AND SENSITIVITY TEST (20 MHz to 100 MHz)**Description**

This test verifies counter operation from 20 MHz to 100 MHz at 25 mVrms (70.7 mV p-p into 50 ohms). The oscilloscope is used to set signal levels.

Equipment

Sweep generator (Wiltron 6668B)
Source locking counter (EIP 578B)
Power splitter (Hewlett Packard 11667B)
Oscilloscope (Tektronix 475)
50 ohm termination (Pomona 4119-50)

Test Setup 2

Figure 5-3. Band 1 Range and Sensitivity Test Setup (20 MHz to 100 MHz).

Procedure

1. Connect equipment as shown in Figure 5-3.
2. Set the 25B/28B counter to Band 1 and select resolution 3.
3. Using the EIP 578B counter, source lock the sweeper at 20 MHz.
4. Using the oscilloscope, set the output signal level from the synthesizer to 25 mVrms (70.7 mV p-p into 50 ohms).
5. Apply the 20 MHz signal to the 25B/28B counter, verify proper reading, and record the results.
6. Repeat steps 3, 4, and 5 at 50 MHz and 100 MHz.

BAND 2 RANGE AND SENSITIVITY TEST

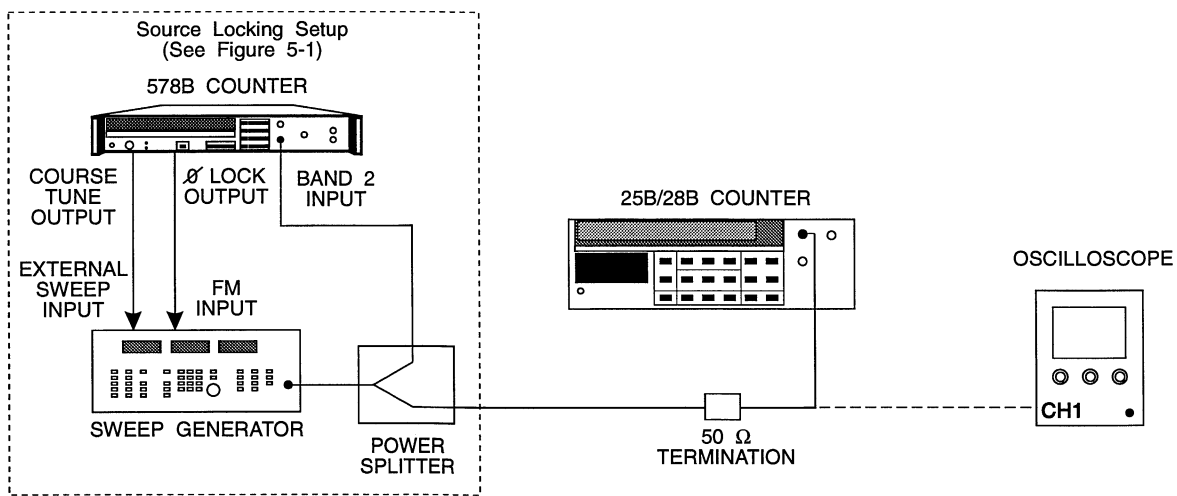
Description

This test verifies counter operation from 10 MHz to 1 GHz at -20 dBm. The power meter is used to set signal levels.

Equipment

Sweep generator (Wiltron 6668B)
 Source locking counter (EIP 578B)
 Power meter (Hewlett Packard 437B)
 Power sensor (Hewlett Packard 8481A)
 Power splitter (Hewlett Packard 11667B)

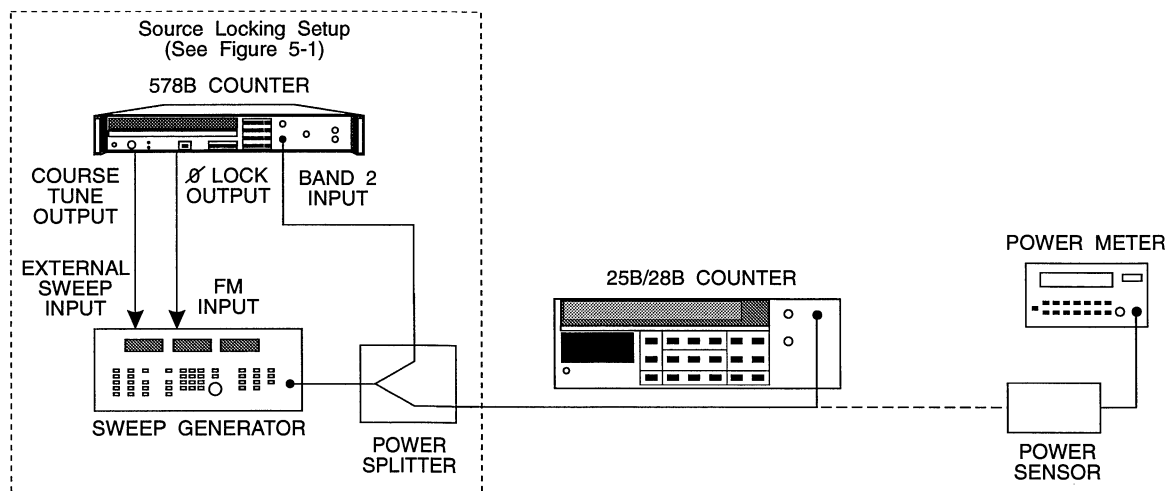

Figure 5-4. Band 2 Range and Sensitivity Test Setup.

Procedure

1. Connect equipment as shown in Figure 5-4.
2. Set the 25B/28B counter to Band 2 and select resolution 3.
3. Using the EIP 578B counter, source lock the sweeper at 10 MHz.
4. Using the power meter, set the output signal level from the sweeper to -20 dBm.
5. Apply the 10 MHz signal to the counter, verify proper reading, and record the results.
6. Repeat steps 3, 4, and 5 at 100 MHz, 300 MHz, 500 MHz, 700 MHz, 900 MHz, and 1 GHz.

BAND 3 RANGE AND SENSITIVITY TEST

Description

This test verifies counter operation from 1 GHz to 20 GHz (26.5 GHz for the 28B counter).

Equipment

Sweep generator (Wiltron 6668B)
 Source locking counter (EIP 578B)
 Power meter (Hewlett Packard 437B)
 Power sensor (Hewlett Packard 8485A)
 Power splitter (Hewlett Packard 11667B)

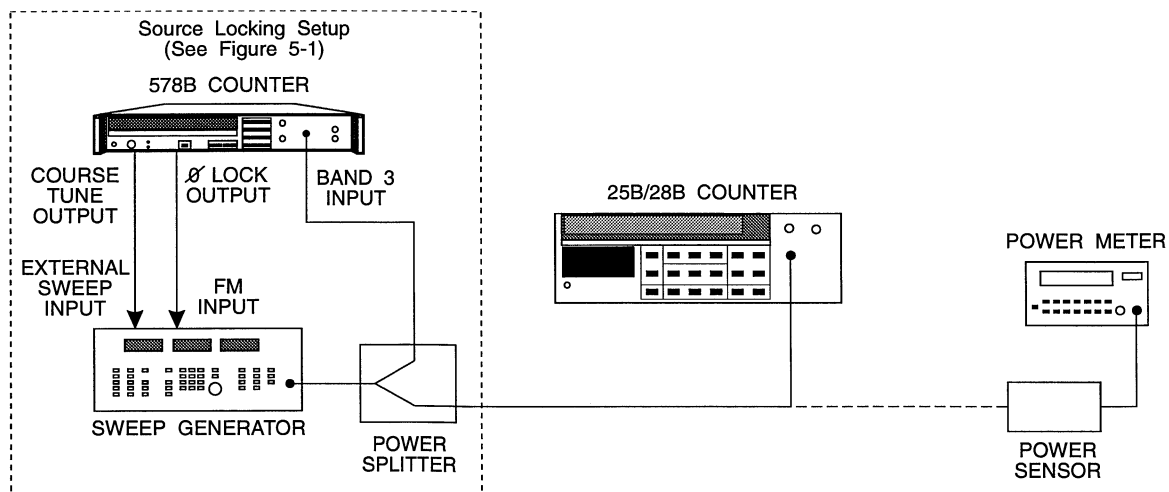

Figure 5-5. Band 3 Range and Sensitivity Test Setup.

Procedure

1. Connect equipment as shown in Figure 5-5.
2. Set the counter to Band 3 and select resolution 3.
3. Using the EIP 578B counter, source lock the sweeper at 1 GHz.
4. Using the power meter, set the output signal level from the sweeper to -30 dBm.
5. Apply the 1 GHz signal to the 25B/28B counter, verify proper reading, and record the results.
6. Repeat steps 3, 4, and 5 at 3 GHz, 5 GHz, 10 GHz, and 12.4 GHz. Then, at a signal level of -25 dBm, test at 15 GHz, 18 GHz, and 20 GHz. For Model 28B counters only: At a signal level of -20 dBm, test also at 22 GHz, 24 GHz, and 26.5 GHz.

BAND 3 AMPLITUDE DISCRIMINATION TEST

Description

This test verifies that the counter will measure accurately the larger of two signals differing in amplitude by 10 dB or more.

Equipment

Sweep generator (Wiltron 6635A)
 Sweep generator (Wiltron 6668B)
 Spectrum analyzer (Hewlett Packard 8566B)
 Power splitter (Hewlett Packard 11667B)

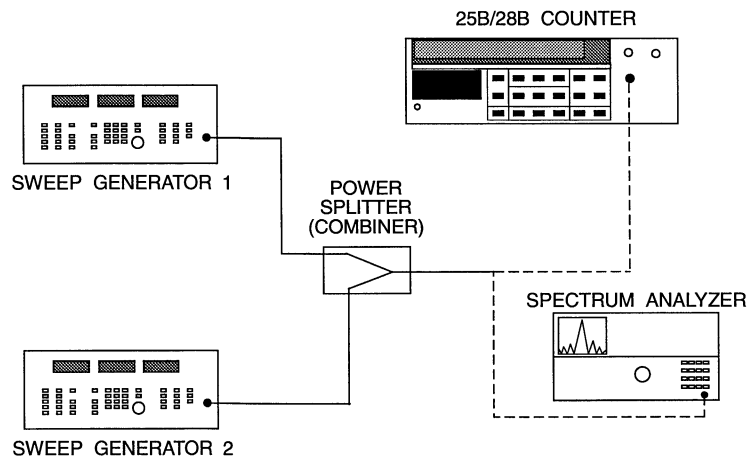
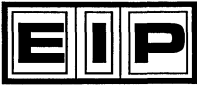

Figure 5-6. Band 3 Amplitude Discrimination Test Setup.

Procedure

1. Connect equipment as shown in Figure 5-6.
2. Set signal generator 1 to 3.0 GHz at 0 dBm and set signal generator 2 to 3.1 GHz at +6 dBm.
3. Using the spectrum analyzer, adjust the generator power levels so that the signal amplitude difference is 10 dB.
4. Verify that the counter correctly measures the frequency of the higher power signal source.
5. Repeat steps 2, 3, and 4 at 6 GHz and 6.1 GHz, at 12 GHz and 12.1 GHz, and at 17.9 GHz and 18 GHz. For the 28B, test also at 22 GHz and 22.1 GHz, and at 26 GHz and 26.1 GHz.



OPERATIONAL TEST RECORD

MODEL: 25B/28B SERIAL NO.: _____ CCN: _____ DATE: _____

TEST	ACTUAL	SPECIFICATIONS
------	--------	----------------

BAND 1 RANGE AND SENSITIVITY TEST **10 Hz TO 100 MHz**

INPUT SENSITIVITY	10 Hz _____	25 mVrms
	100 Hz _____	
	1 kHz _____	
	10 kHz _____	
	100 kHz _____	
	1 MHz _____	
	10 MHz _____	
	20 MHz _____	
	50 MHz _____	
	100 MHz _____	

BAND 2 RANGE SENSITIVITY TEST **100 MHz TO 1 GHz**

INPUT SENSITIVITY	10 MHz _____	-20 dBm
	100 MHz _____	
	300 MHz _____	
	500 MHz _____	
	700 MHz _____	
	900 MHz _____	
	1 GHz _____	

BAND 3 RANGE AND SENSITIVITY TEST **1 GHz TO 26.5 GHz**

INPUT SENSITIVITY	1 GHz _____	-30 dBm
	3 GHz _____	
	5 GHz _____	
	10 GHz _____	
	12.4 GHz _____	
INPUT SENSITIVITY	15 GHz _____	-25 dBm
	18 GHz _____	
	20 GHz _____	
INPUT SENSITIVITY (28B)	22 GHz _____	-20 dBm
	24 GHz _____	
	26.5 GHz _____	

BAND 3 AMPLITUDE DISCRIMINATION TEST **CONDITIONS: F1 > F2 BY 10 dB OR MORE.**

	F1	F2	PASS	FAIL	10 dB
28B	3 GHz	3.1 GHz	_____	_____	
	6 GHz	6.1 GHz	_____	_____	
	12 GHz	12.1 GHz	_____	_____	
	17.9 GHz	18 GHz	_____	_____	
	22 GHz	22.1 GHz	_____	_____	
	26 GHz	26.1 GHz	_____	_____	